

3,4-ROWS DUCT FAN COIL UNIT

INSTALLATION & OPERATION MANUAL

SF-XXXD3
SF-XXXD4



sinclair
AIR CONDITIONING

“Original instructions”

IMPORTANT NOTE:

Read this manual carefully before installing or operating your new air conditioning unit. Make sure to save this manual for future reference.

CONTENTS

PAGE

PRECAUTIONS.....	1
INSTALLATION INFORMATION.....	2
FUNCTIONS & FEATURES	2
ACCESSORIES.....	2
OPERATION RANGE.....	2
PARTS NAMES.....	3
INSTALLATION	3
PIPE CONNECTION.....	6
INSTALLATION DRAINAGE PIPE.....	6
WIRING.....	7

1. PRECAUTIONS

- Be sure to be in conformity with the local, national and international laws and regulations.
- Read "PRECAUTIONS" carefully before installation.
- The following precautions include important safety items. Observe them and never forget.
- Keep this manual in a handy place for future reference.
- Before out from factory, FAN COIL UNIT (AIR UNITS) has passed Fan Coil Overpressure Resistant Test, Statically and Dynamically Balanced Adjustment, Noise Test, Air (cool) Volume Test, Electric Property Test, Outline Quality Detection.

The safety precautions listed here are divided into two categories. In either case, important safety information is listed which must be read carefully.



WARNING

Failure to observe a warning may result in death.



CAUTION

Failure to observe a caution may result in injury or damage to the equipment.

After completing the installation, make sure that the unit operates properly during the start-up operation. Please instruct the customer on how to operate the unit and keep it maintained.



WARNING

Be sure only trained and qualified service personnel to install, repair or service the equipment.

Improper installation, repair, and maintenance may result in electric shocks, short-circuit, leaks, fire or other damage to the equipment.

Install according to this installation instructions strictly. If installation is defective, it will cause water leakage, electrical shock and fire.

When installing the unit in a small room, take measures against to keep refrigerant concentration from exceeding allowable safety limits in the event of refrigerant leakage. Contact the place of purchase for more information. Excessive refrigerant in a closed ambient can lead to oxygen deficiency.

Use the attached accessories parts and specified parts for installation. otherwise, it will cause the set to fall, water leakage, electrical shock and fire.

The appliance must be installed 2.3m above floor.

The appliance shall not be installed in the laundry.

Before obtaining access to terminals, all supply circuits must be disconnected.

The appliance must be positioned so that the plug is accessible.

The enclosure of the appliance shall be marked by word, or by symbols, with the direction of the fluid flow.

For electrical work, follow the local national wiring standard, regulation and this installation instructions. An independent circuit and single outlet must be used. If electrical circuit capacity is not enough or defect in electrical work, it will cause electrical shock fire.

Use the specified cable and connect tightly and clamp the cable so that no external force will be acted on the terminal. If connection or fixing is not perfect, it will cause heat-up or fire at the connection.

Wiring routing must be properly arranged so that control board cover is fixed properly. If control board cover is not fixed perfectly, it will cause heat-up at connection point of terminal, fire or electrical shock.

If the supply cord is damaged, it must be replaced by the manufacture or its service agent or a similarly qualified person in order to avoid a hazard.

An all-pole disconnection switch having a contact separation of at least 3mm in all poles should be connected in fixed wiring.

When carrying out piping connection, take care not to let air substances go into refrigeration cycle. Otherwise, it will cause lower capacity, abnormal high pressure in the refrigeration cycle.

Do not modify the length of the power supply cord or use of extension cord, and do not share the single outlet with other electrical appliances. Otherwise, it will cause fire or electrical shock.

If the water leaks during installation, ventilate the area immediately.

After completing the installation work, check that the water does not leak.

The cool water in the unit is not lower than 3°C, hot water is not higher than 80°C. Water in the unit must clean, air quality must meet to the standard of PH=6.5~7.5.



CAUTION

Before installing the unit, it is necessary to check whether the ground wire is charged.

If it is, the unit shall not be installed before correction.

Ground the air conditioner.

Do not connect the ground wire to gas or water pipes, lightning rod or a telephone ground wire. Incomplete grounding may result in electric shocks.

Be sure to install an earth leakage breaker.

Failure to install an earth leakage breaker may result in electric shocks.

Connect the outdoor unit wires, then connect the indoor unit wires.

You are not allowed to connect the air conditioner with the power source until wiring and piping the air conditioner is done.

While following the instructions in this installation manual, install drain piping in order to ensure proper drainage and insulate piping in order to prevent condensation.

Improper drain piping may result in water leakage and property damage.

Install the indoor and outdoor units, power supply wiring and connecting wires at least 1 meter away from televisions or radios in order to prevent image interference or noise.

Depending on the radio waves, a distance of 1 meter may not be sufficient enough to eliminate the noise.

This appliance can be children aged from 8 years and above and persons with reduced physical, sensory or mental capabilities or lack of experience and knowledge if they have been given supervision or instruction concerning use of the appliance in a safe way and understand the hazards involved. Children shall not play with the appliance. Cleaning and user maintenance shall not be made by children without supervision.



DISPOSAL: Do not dispose this product as unsorted municipal waste. Collection of such waste separately for special treatment is necessary.

Do not dispose of electrical appliances as unsorted municipal waste, use separate collection facilities.

Contact your local government for information regarding the collection systems available.

If electrical appliances are disposed of in landfills or dumps, hazardous substances can leak into the groundwater and get into the food chain, damaging your health and well-being.

Disconnect the power supply before cleaning and maintenance. Use dry cloth to clean the unit.

Don't install the air conditioner in the following locations:

- There is petrolatum existing.
- There is salty air surrounding (near the coast).
- There is caustic gas (the sulfide, for example) existing in the air (near a hot spring).
- The Volt vibrates violently (in the factories).
- In buses or cabinets.
- In kitchen where it is full of oil gas.
- There is strong electromagnetic wave existing.
- There are inflammable materials or gas.
- There is acid or alkaline liquid evaporating.
- Other special conditions.

2. INSTALLATION INFORMATION

- To install properly, please read this "Owner's & Installation manual" at first.
- The air conditioner must be installed by qualified persons.
- When installing the indoor unit or its tubing, please follow this manual as strictly as possible.
- If the air conditioner is installed on a metal part of the building, it must be electrically insulated according to the relevant standards to electrical appliances.
- When all the installation work is finished, please turn on the power only after a thorough check.
- Regret for no further announcement if there is any change of this manual caused by product improvement.

3. FUNCTIONS & FEATURES

- Nested in the ceiling, space-saving and noble.
- High capacity of cooling / heating performance, high efficiency and energy-saving.
- Adjust the indoor temperature rapidly and averagely.
- Low noise design.
- The air outlet is laid out in the way you desire.

4. ACCESSORIES

Table 4-1

Accessory Name	Qty.	Sharp	Purpose
Owner's & installation manual	1	This manual	——
Accessional plastic water tray (no air return box type without)	1		——

5. OPERATION RANGE

Use the system in the following temperature for safe and effective operation.

Table 5-1

Temperature Mode	Outdoor temperature	Room temperature	Water inlet temperature
Cooling operation	0°C~43°C	17°C~32°C	3°C~20°C
Heating operating (cooling only type without)	-15°C~24°C	0°C~30°C	30°C~80°C



NOTE

- 1 If air conditioner is used outside the above conditions, it may cause the unit to function abnormally.
- 2 The phenomenon is normal that the surface of air conditioning may condense water when the relative larger humidity in room, please close the door and window.
- 3 Optimum performance will be achieved within these operating temperature range.
- 4 Water system operating pressure: Max: 1.6MPa, Min: 0.15MPa.

6. PARTS NAMES

The above figures is an instance models, which would be different from the one that you purchase.

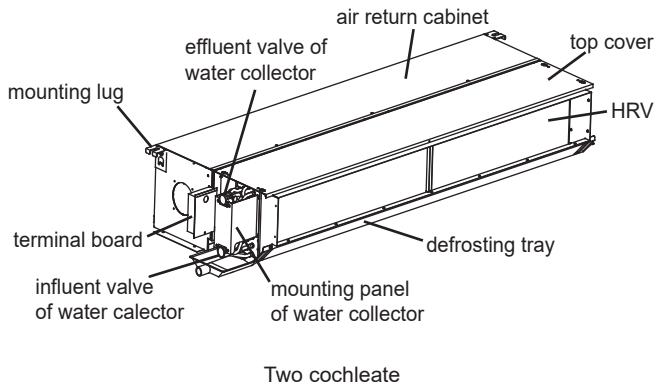

Fig.6-1

7. INSTALLATION

7.1 Installing site

- Install the unit where enough space of installation and maintenance is available.
- Install the unit where the ceiling is horizontal and enough for bearing the weight of the indoor unit.
- Install the unit where the air inlet and outlet are not baffled and are the least affected by external air.
- Install the unit where the supply air flow can be sent to all parts in the room.
- Install the unit where it is easy to lead out the connective pipe and the drain pipe.
- Install the unit where connotative heat is emitted from a heat source directly.



CAUTION

- Installing the equipment in any of the following places may lead to faults of the equipment (if that is inevitable, consult the supplier):
 - The site contains mineral oils such as cutting lubricant.
 - Seaside where the air contains much salt.
 - Hot spring area where corrosive gases exist, e.g., sulfide gas.
 - Factories where the supply voltage fluctuates seriously.
 - Inside a car or cabin.
 - Place like kitchen where oil permeates.
 - Place where strong electromagnetic waves exist.
 - Place where flammable gases or materials exist.
 - Place where acid or alkali gases evaporate.
 - Other special environments.

■ Precautions before installation

- Decide the correct way of conveying the equipment.
- Try to transport this equipment with the original package.
- If the air conditioner needs to be installed on a metal part of the building, electric insulation must be performed, and the installation must meet the relevant technical standards of electric devices.
- Before installing the unit, be sure to confirm with the user whether there are wires, water pipes, air pipes and so on in the wall or ground of the installation site to avoid accidents due to damage.

7.2 Installing the fan coil units

Confirm the dimensions of the indoor unit against the following figure.

Install $\Phi 10$ pendant bolts (4 bolts)

- The intervals of the pendant bolts are shown in the following figure.
- Use the $\Phi 10$ pendant bolts.
- The treatment of the ceiling varies between buildings. For detailed measures, negotiate with the construction and fit-out staff.
- Scope of dismantling the ceiling... Please keep the ceiling horizontal. Reinforce the beams and girders of the ceiling lest vibration of the ceiling.
- Cut off the beams and girders of the ceiling.
- Reinforce the cut-off part, beams and girders of the ceiling.
- After the main body is suspended, work on the pipes and wires in the ceiling. Decide the lead-out direction of the pipes after selecting the installation site. Especially, in a circumstance where a ceiling is available, extend the refrigerant pipe, drain pipe, indoor/outdoor connection wires and wire controller lines to the connection position before suspending the unit.

7.2.1 Procedure of installing the pendant bolts.

- Base on the unit structure, please set the screw-pitch according to the size of the following figures:
- Wooden structure
 - Put rectangular sticks across the beams, and set pendant bolts.

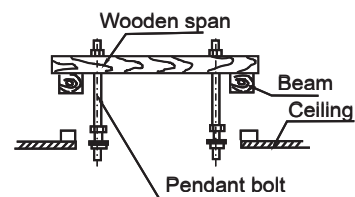

Fig.7-1

- Old concrete roughcast
 - Use embedded bolts and embedded pulling plugs.

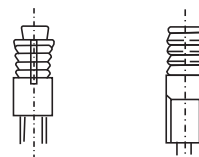

Fig.7-2

- Steel beam and girder structure
 - Set and use supportive angle steel.

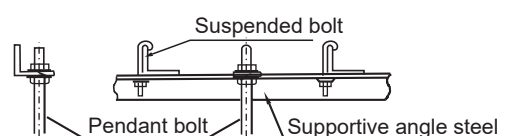

Fig.7-3

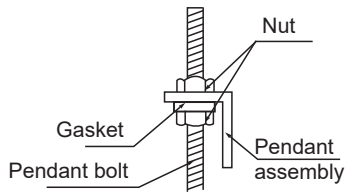

Fig. 7-4

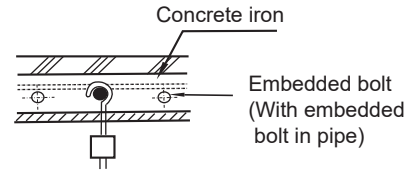

Fig. 7-6

- New concrete roughcast
Set it with embedded bushes or embedded bolts.



Fig. 7-5

■ **Suspending the indoor unit**

- Use tools such as pulleys to hoist the indoor unit to the pendant bolt.
- Use tools such as gradienter to settle the indoor unit horizontally. Lack of horizontality may cause water leak.

■ **Connect the duct**

The duct length is determined according to the external static pressure.

■ **Install the wire control switch**

For installation of the wire control switch, see the installation manual of the wire controller.

7.2.2 Space requirement.

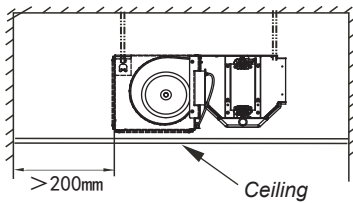

Fig. 7-7

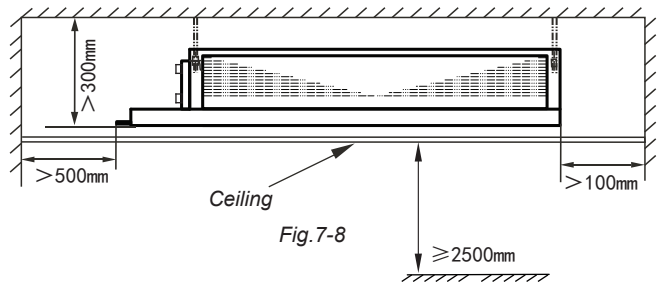

Fig. 7-8

7.2.3 Sample unit specification figure

2-Row Duct and 4-Row Duct Two pipe type (unit:mm)

The quantities of the fans and motors are only for reference, please prevail in kind!

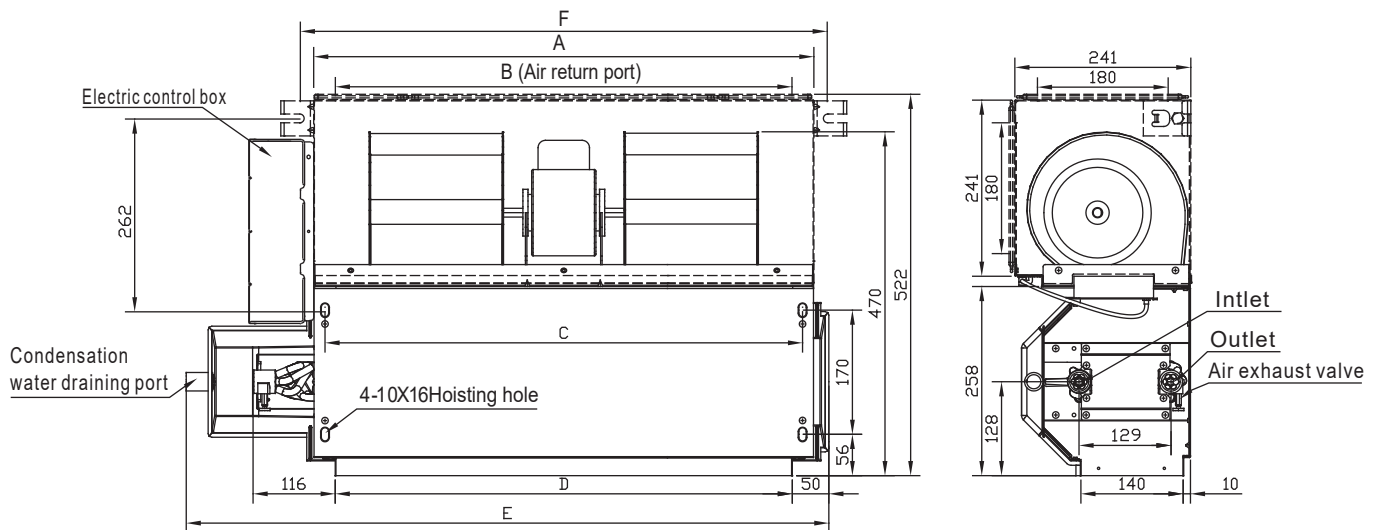

Fig. 7-9.1

3-Row Duct Two pipe type (unit:mm)

The quantities of the fans and motors are only for reference, please prevail in kind!

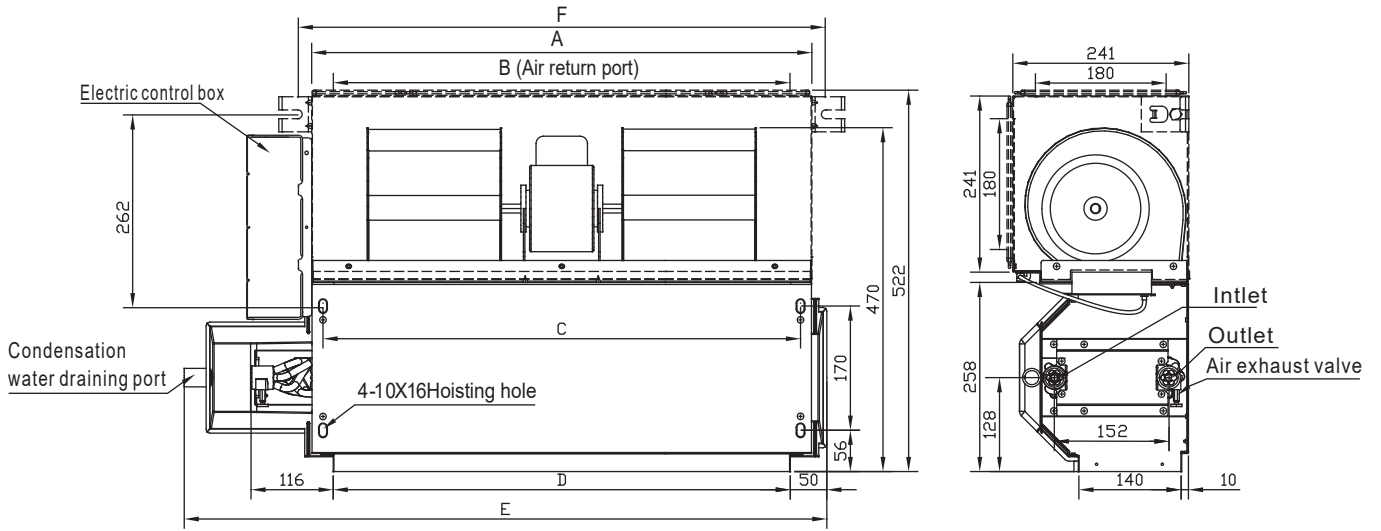

Fig.7-9.2

Four pipe type (unit:mm)

The quantities of the fans and motors are only for reference, please prevail in kind!

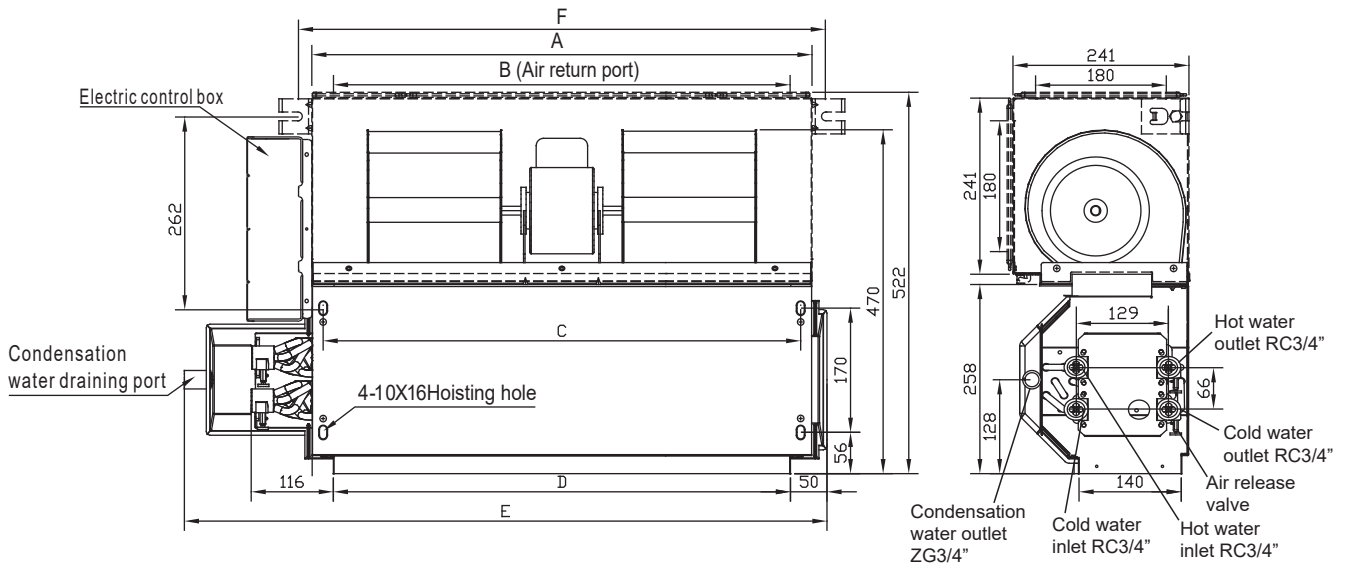

Fig.7-10

Table 7-1

Size \ Model	200-Model	300-Model	400-Model 500-Model	600-Model	800-Model	1000-Model	1200-Model	1400-Model
A	545	645	745	965	1265	1370	1660	1826
B	485	585	685	905	1205	1310	1600	1766
C	513	613	713	933	1233	1338	1628	1794
D	485	585	685	905	1205	1310	1600	1766
E	741	841	941	1161	1461	1566	1856	2022
F	583	683	783	1003	1303	1408	1698	1864



NOTE

- The above figures is an instance models, which would be different from the one that you purchase.
- The broken lines in above figures for illustrate the dimension of air return box. (Lower side air return box and rear air return box)
- If you need to order air return box from us, please be specific describe which kind you need.

7.3 Connect the accessional plastic water tray (no air return box type without)

- The grooves of the accessional plastic water tray can be locked at the brim of the main water tray.

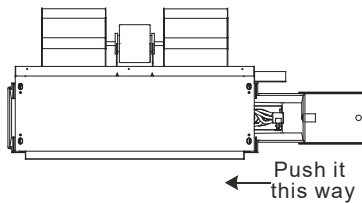

Fig. 7-9

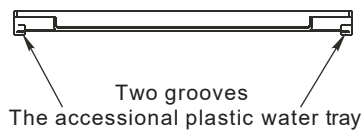

Fig. 7-10

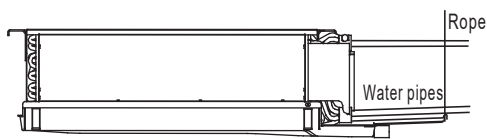

Fig. 7-11

- Please hang up the accessional plastic water tray to the pipes or ceiling by a rope.

8. PIPES CONNECTION

- With air release valve, the other side is water inlet pipe.
- When connect water collector, set the tightening torque to 6180~7540N.cm(630~770kgf.cm), and use a spanner to tighten it as shown in Figure.
- The diameter of connective junction in water inlet pipe and water outlet pipe is RC3/4 taper pipe thread inside.
- The diameter of condensate pipe is ZG3/4 taper pipe thread outside.

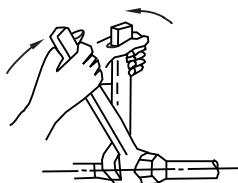

Fig. 8-1

9. INSTALLING DRAINAGE PIPE

- **Install the drain pipe of the fan coil unit**
Before out from factory, the scupper adopts the pipe thread.



NOTE

- Be sure to perform heat insulation for the drain pipe of the indoor unit. Otherwise, condensate will occur. The joint of the indoor unit should also undergo heat insulation treatment.
- When performing the pipes connection, use the rigid PVC binder, and make sure that no leak exists.
- Same as the joint of the indoor unit. Be careful not to apply force at the pipe side of the indoor unit.
- The downward gradient of the drain pipe should be higher than (1/100), without bend in the middle.
- The total length of the drain pipe when pulled out transversely shall not exceed 20m, when the pipe is over long, a prop stand must be installed prevent winging.
- The centralized pipes should be distributed against the figure shown on the right side.

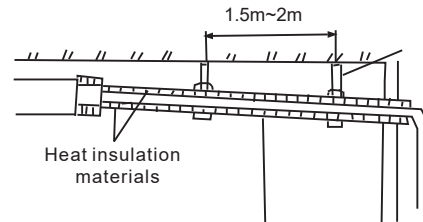

Downward gradient is over 1/100

Fig. 9-1

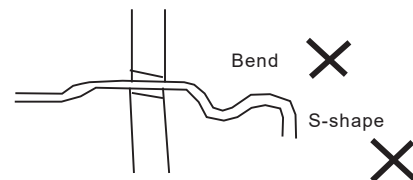

Fig. 9-2

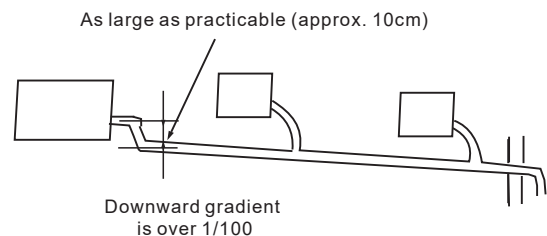

Fig. 9-3

- **Drain test**
 - Before the test, ensure that the drain pipes are smooth and the adapters are sealed.
 - Newly built rooms should undergo the drain test before the ceiling is laid.

10. WIRING



CAUTION

- The air conditioner should use separate power supply with rated voltage.
- The external power supply to the air conditioner should have ground wiring, which is linked to the ground wiring of the indoor and outdoor unit.
- The wiring work should be done by qualified persons according to circuit drawing.
- An all-pole disconnection switch having a contact separation of at least 3mm in all poles should be connected in fixed wiring.
- The appliance shall be installed in accordance with national wiring regulations.
- Be sure to locate the power wiring and the signal wiring well to avoid cross-disturbance.
- Do not turn on the power until you have checked carefully after wiring.
- The temperature of refrigerant circuit will be high, please keep the interconnection cable away from the copper tube.

Table 10-1

AIR FLOW(CFM)		200~1400
POWER	PHASE	1-phase
	FREQUENCY AND VOLT	220-240V~ 50Hz
CIRCUIT BREAKER/FUSE(A)		15/15
INDOOR UNIT POWER WIRING(mm ²)	BELOW 20M	Twisted pairwire: 2.5
	BELOW 50M	Twisted pairwire: 6
GROUND WIRING(mm ²)		2.5

The power cord type designation is H05RN-R or above/H07RN-F.

10.1 Wiring Diagram

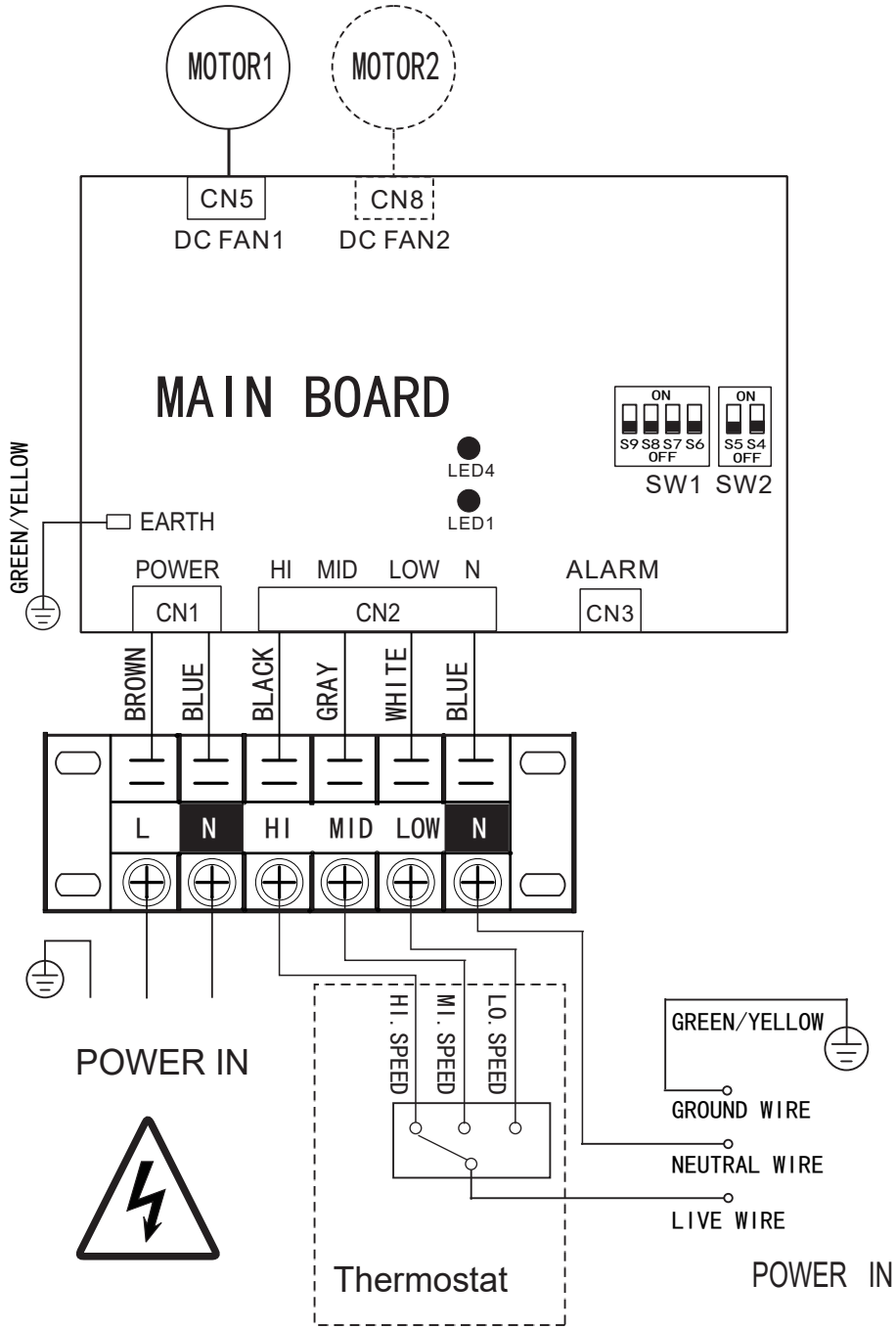

10.2 The default model of DC fan coil is set as 12Pa when leaving the factory.
Clients can dial to the responding position to choose the model and static pressure according to the nameplate and actual static pressure requirements of the models and static dial code table .

Models and static dial code table :

MODE \ STATIC PRESSURE	12Pa	30Pa	50Pa
200CFM (34WA) SINGLE-MOTOR			
300CFM (51WA) SINGLE-MOTOR			
400CFM (68WA) SINGLE-MOTOR			
500CFM (85WA) SINGLE-MOTOR			
600CFM (102WA) SINGLE-MOTOR			
800CFM (136WA) DOUBLE-MOTOR			
1000CFM(170WA) DOUBLE-MOTOR			
1200CFM(204WA) DOUBLE-MOTOR			

10.3 Fault and Protection

When the unit is subject to failure, main board corresponding LED4 will flash.
 Fault code table and Protection:

NO.	Fault Name	Main board LED4 light
1	Fan failure	LED4 light flash 4 (flashing frequency 2Hz) stop 2s, cycle of action
2	Not set models	LED4 light continue to flashing(flashing frequency 2Hz)

The A-weighted sound pressure level is below 70dB.

10.4 Tables

MODE:SF-200D3			
Information to identify the model(s)to which the information relation:			
Item	Symbol	Value	Unit
Cooling capacity(sensible)	Prated,c	1.75	kW
Cooling capacity(latent)	Prated,c	0.6	kW
Heating capacity	Prated,h	2.68	kW
Total electric power input	Pelec	0.017	kW
Sound power level(per speed setting,if applicable)	LWA	50/40/33	dB
contact details			

MODE:SF-300D3			
Information to identify the model(s)to which the information relation:			
Item	Symbol	Value	Unit
Cooling capacity(sensible)	Prated,c	2.53	kW
Cooling capacity(latent)	Prated,c	0.59	kW
Heating capacity	Prated,h	3.82	kW
Total electric power input	Pelec	0.02	kW
Sound power level(per speed setting,if applicable)	LWA	50/44/37	dB
contact details			

MODE:SF-400D3			
Information to identify the model(s)to which the information relation:			
Item	Symbol	Value	Unit
Cooling capacity(sensible)	Prated,c	3.1	kW
Cooling capacity(latent)	Prated,c	0.89	kW
Heating capacity	Prated,h	4.7	kW
Total electric power input	Pelec	0.026	kW
Sound power level(per speed setting,if applicable)	LWA	52/45/38	dB
contact details			

MODE:SF-500D3			
Information to identify the model(s)to which the information relation:			
Item	Symbol	Value	Unit
Cooling capacity(sensible)	Prated,c	3.5	kW
Cooling capacity(latent)	Prated,c	0.96	kW
Heating capacity	Prated,h	5.27	kW
Total electric power input	Pelec	0.39	kW
Sound power level(per speed setting,if applicable)	LWA	56/48/41	dB
contact details			

MODE:SF-600D3			
Information to identify the model(s)to which the information relation:			
Item	Symbol	Value	Unit
Cooling capacity(sensible)	Prated,c	4.49	kW
Cooling capacity(latent)	Prated,c	1.36	kW
Heating capacity	Prated,h	6.62	kW
Total electric power input	Pelec	0.049	kW
Sound power level(per speed setting,if applicable)	LWA	57/49/42	dB
contact details			

MODE:SF-800D3			
Information to identify the model(s)to which the information relation:			
Item	Symbol	Value	Unit
Cooling capacity(sensible)	Prated,c	6.19	kW
Cooling capacity(latent)	Prated,c	1.83	kW
Heating capacity	Prated,h	9.15	kW
Total electric power input	Pelec	0.06	kW
Sound power level(per speed setting,if applicable)	LWA	58/49/42	dB
contact details			

MODE:SF-1000D3			
Information to identify the model(s)to which the information relation:			
Item	Symbol	Value	Unit
Cooling capacity(sensible)	Prated,c	7.33	kW
Cooling capacity(latent)	Prated,c	1.63	kW
Heating capacity	Prated,h	10.74	kW
Total electric power input	Pelec	0.096	kW
Sound power level(per speed setting,if applicable)	LWA	62/54/45	dB
contact details			

MODE:SF-1200D3			
Information to identify the model(s)to which the information relation:			
Item	Symbol	Value	Unit
Cooling capacity(sensible)	Prated,c	8.84	kW
Cooling capacity(latent)	Prated,c	1.95	kW
Heating capacity	Prated,h	12.62	kW
Total electric power input	Pelec	0.106	kW
Sound power level(per speed setting,if applicable)	LWA	62/54/45	dB
contact details			

MODE:SF-200D4			
Information to identify the model(s)to which the information relation:			
Item	Symbol	Value	Unit
Cooling capacity(sensible)	Prated,c	1.374	kW
Cooling capacity(latent)	Prated,c	0.29	kW
Heating capacity	Prated,h	2.453	kW
Total electric power input	Pelec	0.017	kW
Sound power level(per speed setting,if applicable)	LWA	51.1/41.1/38.7	dB
contact details			

MODE:SF-300D4			
Information to identify the model(s)to which the information relation:			
Item	Symbol	Value	Unit
Cooling capacity(sensible)	Prated,c	2.106	kW
Cooling capacity(latent)	Prated,c	0.447	kW
Heating capacity	Prated,h	3.467	kW
Total electric power input	Pelec	0.022	kW
Sound power level(per speed setting,if applicable)	LWA	51.7/45.0/38.7	dB
contact details			

MODE:SF-400D4			
Information to identify the model(s)to which the information relation:			
Item	Symbol	Value	Unit
Cooling capacity(sensible)	Prated,c	2.445	kW
Cooling capacity(latent)	Prated,c	0.534	kW
Heating capacity	Prated,h	4.309	kW
Total electric power input	Pelec	0.03	kW
Sound power level(per speed setting,if applicable)	LWA	54.3/48.3/40.0	dB
contact details			

MODE:SF-500D4			
Information to identify the model(s)to which the information relation:			
Item	Symbol	Value	Unit
Cooling capacity(sensible)	Prated,c	2.821	kW
Cooling capacity(latent)	Prated,c	0.449	kW
Heating capacity	Prated,h	4.705	kW
Total electric power input	Pelec	0.043	kW
Sound power level(per speed setting,if applicable)	LWA	57.6/50.5/42.5	dB
contact details			

MODE:SF-600D4			
Information to identify the model(s)to which the information relation:			
Item	Symbol	Value	Unit
Cooling capacity(sensible)	Prated,c	3.601	kW
Cooling capacity(latent)	Prated,c	0.805	kW
Heating capacity	Prated,h	6.034	kW
Total electric power input	Pelec	0.05	kW
Sound power level(per speed setting,if applicable)	LWA	59.1/52.2/43.7	dB
contact details			

MODE:SF-800D4			
Information to identify the model(s)to which the information relation:			
Item	Symbol	Value	Unit
Cooling capacity(sensible)	Prated,c	4.73	kW
Cooling capacity(latent)	Prated,c	0.988	kW
Heating capacity	Prated,h	7.226	kW
Total electric power input	Pelec	0.065	kW
Sound power level(per speed setting,if applicable)	LWA	60.2/52.2/44.4	dB
contact details			

MODE:SF-1000D4			
Information to identify the model(s)to which the information relation:			
Item	Symbol	Value	Unit
Cooling capacity(sensible)	Prated,c	6.036	kW
Cooling capacity(latent)	Prated,c	1.242	kW
Heating capacity	Prated,h	8.629	kW
Total electric power input	Pelec	0.097	kW
Sound power level(per speed setting,if applicable)	LWA	62.9/55.8/45.7	dB
contact details			

MODE:SF-1200D4			
Information to identify the model(s)to which the information relation:			
Item	Symbol	Value	Unit
Cooling capacity(sensible)	Prated,c	7.54	kW
Cooling capacity(latent)	Prated,c	1.66	kW
Heating capacity	Prated,h	10.53	kW
Total electric power input	Pelec	0.107	kW
Sound power level(per speed setting,if applicable)	LWA	62/55/45	dB
contact details			

NOTE CONCERNING PROTECTION OF ENVIRONMENT

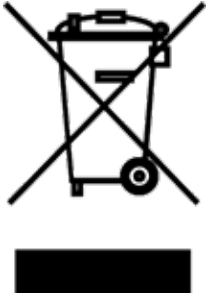

This product must not be disposed of via normal household waste after its service life, but must be taken to a collection station for the recycling of electrical and electronic devices. The symbol on the product, the operating instructions or the packaging indicate such disposal procedures. The materials are recyclable in accordance with their respective symbols. By means of re-use, material recycling or any other form of recycling old appliances you are making an important contribution to the protection of our environment. Please ask your local council where your nearest disposal station is located.

PRODUCER

SINCLAIR CORPORATION Ltd.
16 Great Queen Street
WC2B 5AH London
United Kingdom
www.sinclair-world.com

This product was manufactured in China (Made in China).

REPRESENTATIVE

SINCLAIR Global Group s.r.o.
Purkynova 45
612 00 Brno
Czech Republic

TECHNICAL SUPPORT

SINCLAIR Global Group s.r.o.
Purkynova 45
612 00 Brno
Czech Republic
Tel.: +420 800 100 285 | Fax: +420 541 590 124
www.sinclair-solutions.com | info@sinclair-solutions.com

